

**Biodrier** Business  
**Hand dryer**



**High Speed**

# Surface Mounted High Speed Hand Dryer

## Operating Instructions and Parts Manual



### Technical Specifications

Item Category	Performance Data
Operating Voltage	220 - 240Vac, 50 Hz, 850 WATTS
Warm Air Speed Output	95 m/s
Display	LCD instructions and countdown
Motor Type	18,000 rpm, ICP Brushless DC
Motor Thermal Protection	Auto Resetting Thermostat turns unit off, 240V at 221°F (105°C) - EURO Spec
Heater Element	Not Applicable
Heater Thermal Protection	Not Applicable
Drying Time	Less than 10 seconds
Circuit Operation	Infrared Automatic, self adjusting
Timing Protection	30 seconds auto shut off
Drip Proof	IP22
Isolation	CLASS 1
Net Weight	11 kg
Shipping Weight	13 kg
Unit Size	292mm W x 650mm H x 250mm D
Item Code	Cover Type/Finish
BB07W	ABS White
BB07S	ABS Metallic silver

# Surface Mounted High Speed Hand Dryer

## Operating Instructions and Parts Manual

### General Safety Information

#### **WARNING**

This product is intended for installation by a qualified service person. Use AWAG No.16 solid conductor for wiring.

Failure to properly ground unit could result in electrical shock and/or death.

Disconnect power at the service breaker before installing or servicing.

**NOT FOR HOUSEHOLD USE - MAY CAUSE BURNS**  
"IMPROPRE A L'USAGE DOMESTIQUE - PUET OCCASIONNER."

All units must be supplied with a 2-wire service. The ground wire must be connected with the dryers back plate.

NOTE: Do not install dryer over wash basin.

Type Y attachment

If the power supply cord is damaged, it must be replaced by the manufacturer or its service agent or a similar qualified person in order to avoid a hazard.

Means for disconnection must be incorporated in the fixed wiring in accordance with the wiring rules.

### Installation

1. Make sure power supply breaker is switched off. Installation must be carried out in accordance with the current edition of the local wiring regulations code having jurisdiction. Installation should be performed only by a qualified electrician.

2. Place template against wall at desired height (see mounting height recommendations) and mark locations of 4 mounting holes and wire service entry at knockout (KO) location.

**NOTE: For two or more dryers, dryers should be no closer than 24 inches (610 mm) on centre.**

3. Remove and retain 2 cover screws.

4. Connect supply wires to terminal block where indicated and connect ground wire to baseplate with ground screw.

#### **Connections:**

- a. Connect the live wire (coloured red or brown) to the terminal block marked "L".
- b. Connect the neutral wire (coloured black or blue) to the terminal block marked "N".

**Note that the colour of live and neutral wires depends on voltage of supply service.**

5. Replace cover screens. Do not over-tighten.

# Surface Mounted High Speed Hand Dryer

## Operating Instructions and Parts Manual

### Recommended Mounting Heights

From floor to bottom of dryer.

Men's	Ladies	Children, ages 11-17	Children, ages 3-10	Disabled
13"	11"	10"	6"	4"
350 mm	300 mm	250 mm	150 mm	100 mm

### Consumables

#### Biodrier Anti Bacterial Filter

The Anti Bacterial Filter is fitted to ensure dust and airborne bacteria are restricted from entering the internal components and airflow of the dryer. The filter should be replaced every 3-6 months, depending on usage.

Product	Order Code
Antibacterial HEPA filter	HD-BUSI-HEPA-FILTER
Moisturising Gel	BB70GELS

#### Biodrier Gels

Biodrier Gels are manufactured exclusively for Biodrier and performs 3 jobs in one:

1. Moisturise the hands.
2. Sanitise the product internally, and the users hands.
3. Fragrances the surrounding washroom area whilst in use.

The Gels are manufactured from natural sources and are chemical free.



### Operation

- No touch operation.
- Shake excess water from hands.
- Place hands onto the aperture.
- Move hands up and down (as per CPU instruction).
- Stops automatically after hands are removed.

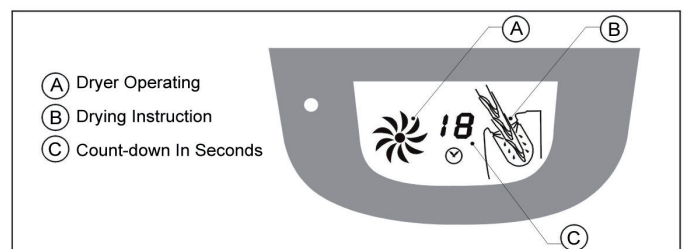

# Surface Mounted High Speed Hand Dryer

## Operating Instructions and Parts Manual

### Cleaning and Maintenance Instructions

Periodic cleaning of the unit is recommended to ensure optimum performance.

- Switch to service mode located on the top right side of the dryer.
- Wipe the cover with a soft cloth and a mild cleaning solution. Do not Soak. Never use abrasives to clean the cover.

### WARNING

- Never spray water directly onto hand dryer
- Never use any abrasives or harsh chemicals
- Turn off electricity prior to cleaning the hand dryer

5. Disassemble drain tank and rinse clean using a disinfectant, then replace.

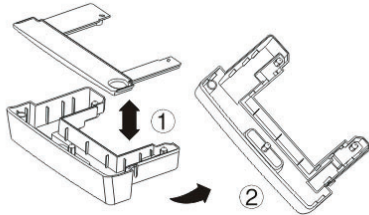

6. Wipe down the external surfaces of the Biodrier Business hand dryer with a soft cloth. Switch power back on and test operation.

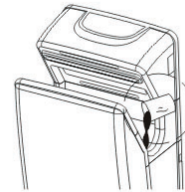

1. Pour a cup of water down drain hole. Use cleaning brush supplied to clean drain hole.

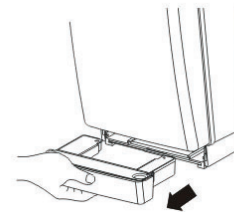

2. Remove drain tank and empty.

4. Clean filter casing by wiping with soft damp cloth. Replace the antibacterial filter every 3 months. Moisturising gels should be replaced every month. Slide filter back into place.

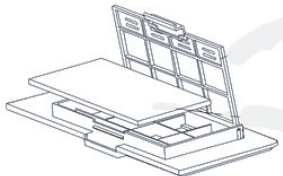

3. Remove filter.

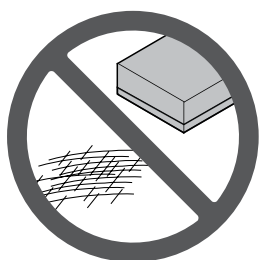

# Surface Mounted High Speed Hand Dryer

## Operating Instructions and Parts Manual

### Diagram

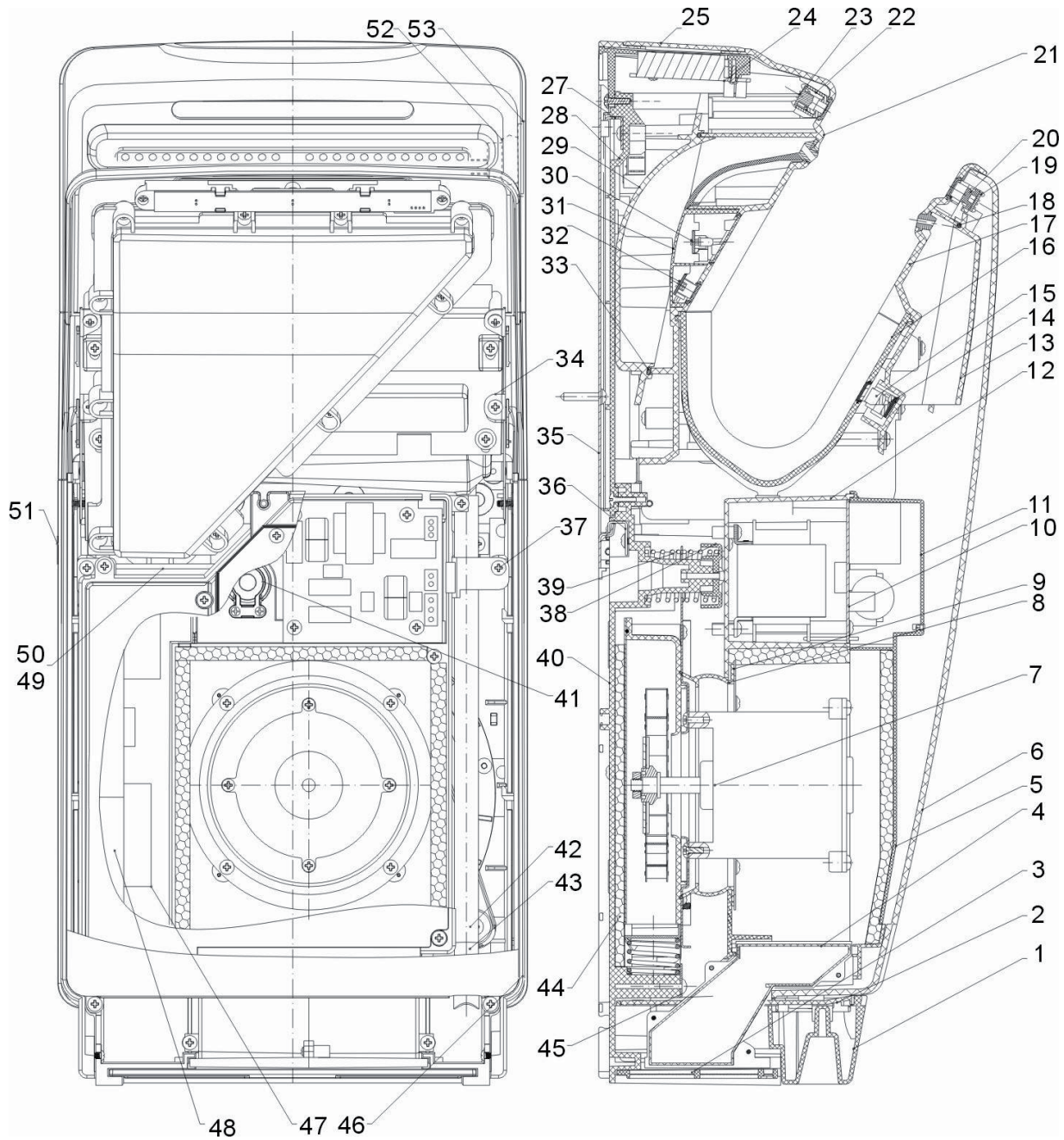

# Surface Mounted High Speed Hand Dryer

## Operating Instructions and Parts Manual

### Parts List

Key	Description
1	Water tank
2	Cover
3	Filter
4	Air inlet
5	Motor cover
6	Front cover
7	motor and air home
8	Sound insulation cover
9	Fixer
10	Circuitry A
11	Connection converter
12	motor cover
13	Front air out cover
14	Circuitry C
15	Bracket
16	Connector
17	Front air shell
18	Front airproof
19	Circuitry D
20	Plus screw
21	Back screen
22	Bracket
23	Circuitry E
24	Circuitry F
25	LCD dashboard
26	Bracket
27	Bis pothook
28	Back board
29	Back air cover
30	Circuitry G
31	Light box
32	Circuitry H
33	Back airproof
34	Connected board B
35	Fixing board
36	Small pothook
37	Plus screw
38	Spring
39	Spring fixed cover
40	Main body
41	Mica board
42	Hose
43	Outlet rubber
44	Celotex A
45	Block Spring
46	Sideboard
47	Circuitry box
48	Circuitry B
49	Fix loop
50	Air connector
51	Nut
52	Switch
53	Switch button

**Biodrier.** com



FW3 LTD, Biodrier  
West Hill, Exeter, EX11 1LQ  
tel: +44(0)1404 814292 • email: sales@biodrier.com